

Wisco Products 600 SERIES Filler Caps and Accessories

Superior filler systems for fluid storage closures

Wisco Products is a precision manufacturer of filler caps, necks and accessories for a broad range of markets including heavy-duty transportation, industrial, agricultural, locomotive, and motor sport, among others. Our high quality heavy gauge materials — plus precision fabrication — make these products flexible, dependable choices for your filler system needs.

Our 600 Series products match applications with a sealing area of about 4 inches diameter (see the drawing). A variety of cap and neck styles and materials accommodate fuel, oil, hydraulic and water closure systems for all types of plant and field fluid storage applications. Accessory options let you build the filler assembly you need.

Three different strainers provide varying degrees of filtration for 600 Series caps and necks to help you maintain clean fluids within your storage system. Special mountings match the type of connections you require.

You'll also find Wisco Products a willing expert at satisfying your custom needs. Each filler item from Wisco offers the same attention and quality assurance regardless of your order quantity.

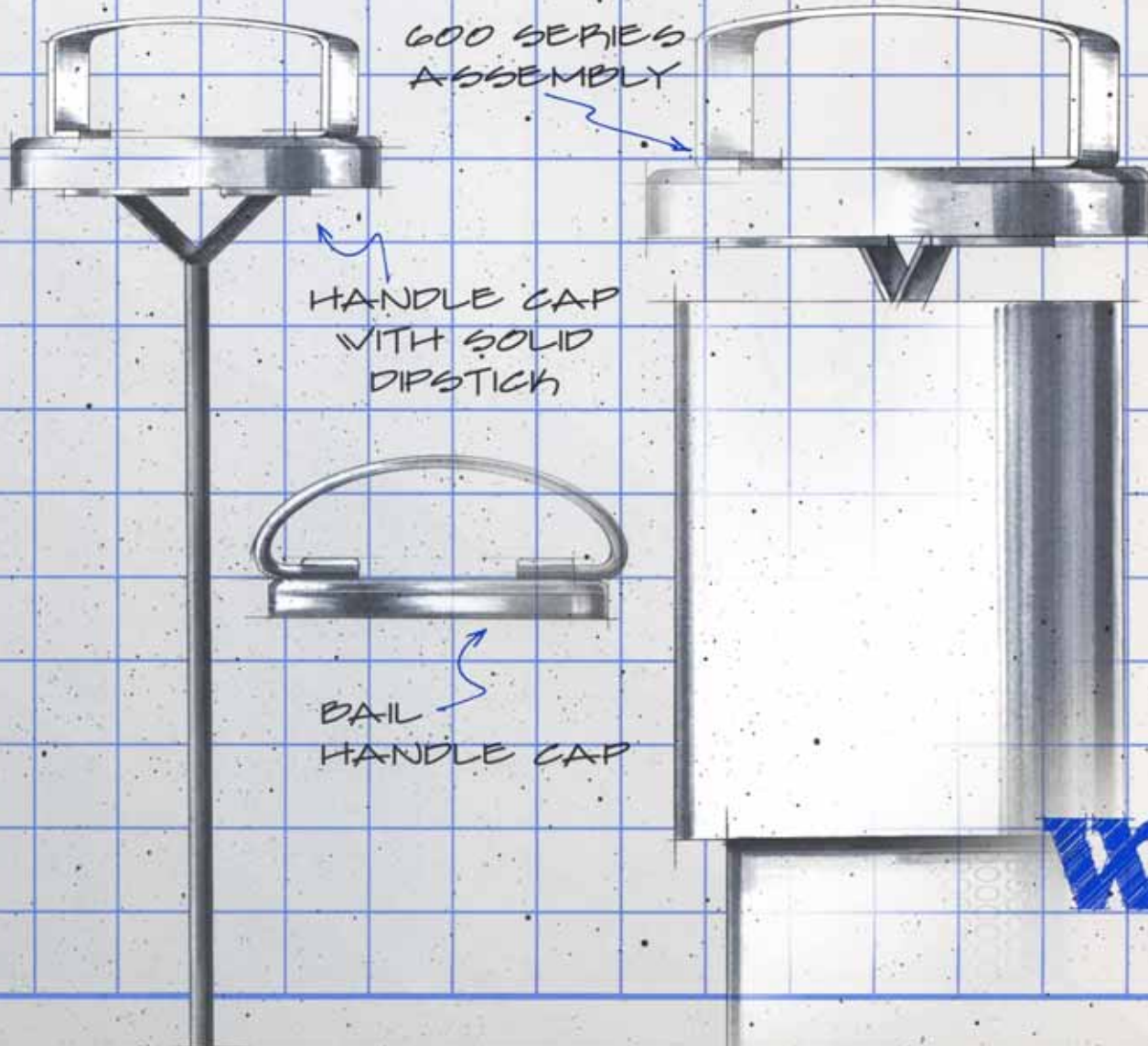







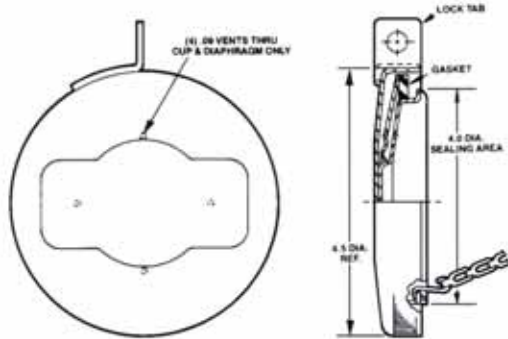



600 SERIES CAPS

Our high quality caps offer flexible, durable performance for a variety of fluid storage systems.

- For use with fuel and other fluid tank closures
- 18 gauge (.048 in.) steel or stainless steel cover
- Optional lock tab or key lock to prevent loss, theft, or vandalism
- Includes standard 8-in. stainless link chain



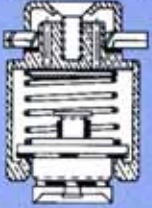

Style	Material	Plating	Pressure	Gasket	Chain	Lock Tab Key Lock	Dipstick
601 Knurled 	Steel	Zinc, clear	Non Vented	3944 Fibreflex (Prestboard)	 Stainless link	 Lock Tab (Steel or Stainless Steel)	(Specify Length and Markings)
602 Handle 	Stainless Steel	Zinc, yellow	Vented Filtered Vent Unit 	4135 Buna "N" Nitrile	 "S" Hook		
603 Bail Handle 			100 x 90 or 40 x 40 Stainless Mesh Vacuum Release  (Will not vent to the atmosphere)	4135-1 Synthetic Rubber (MIL-R-3065 MIL-STD-417)	 Stainless Snap Hook		
			Low Pressure Valve with Vacuum Release 	4135EP Ethylene Propylene			
							Other (Specify)

600 SERIES NECKS

Our 600 Series necks provide the same high quality materials and precision as our caps so you can exactly match your fluid reservoir requirements.

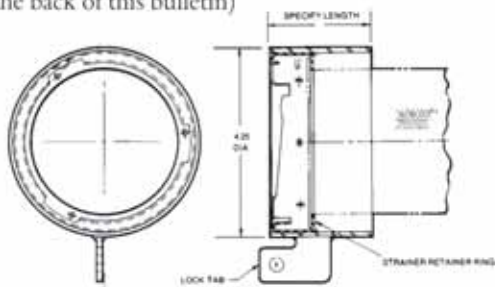
- For use with 600 Series caps
- 0.095-in. wall tubing with internal cam spot welded in place
- Lock tab option prevents loss, theft, or vandalism
- Available with mountings and strainers (see the back of this bulletin)

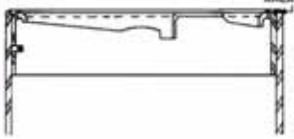

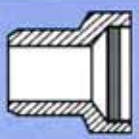
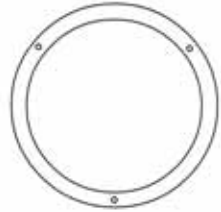
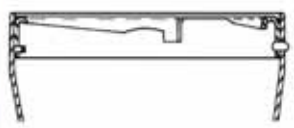
Style*	Material	Plating	Chain	Lock Tab	Vent	Strainer Ring
625 Standard/Welded 	Steel	Zinc, clear	Per Customer Request	 Steel, Stainless Steel, or Aluminum	 Filtered Vent (Nylon with Stainless Steel Sintered Disk - 46 Micron)	 Steel or Stainless Steel
625 Standard/Riveted 	Stainless Steel	Zinc, yellow				
Aluminum Only						
*Specify Overall Length						

600 SERIES STRAINERS

- For use with 600 Series necks and caps
- 22 gauge (.030 in.) perforated steel
- Standard .060 in. diameter holes on .094 in. staggered centers; 126 holes per sq. in. provide 36% open area
- Filtration enhancement available:
 - 40 x 40 mesh (.010 in. diameter wire) stainless wire cloth; 381 micron filtration
 - 100 x 90 mesh (.0045 in. diameter wire) stainless wire cloth; 127 micron filtration



Style	Material	Plating	Filtration	Length	Samples		
650 Standard	Steel	Zinc, yellow	40 x 40 mesh	(Specify)	Strainer	40 x 40 mesh	100 x 90 mesh
	Stainless Steel		100 x 90 mesh				

600 SERIES MOUNTINGS

- Must be ordered with neck
- Necks welded, brazed, or silver soldered to mountings
- Internal pipe thread available in steel only; PT-2", PT-3", PT-3.5", PT-4"
- Straight Tube available in steel, stainless steel, or aluminum; specify length
- Bolt or Weld Flange/Tube Mounting available on steel, stainless steel, or aluminum tube; specify length; flange welded on OD of tube
- Bolt or Weld Flange/Neck Mounting available on steel or stainless steel

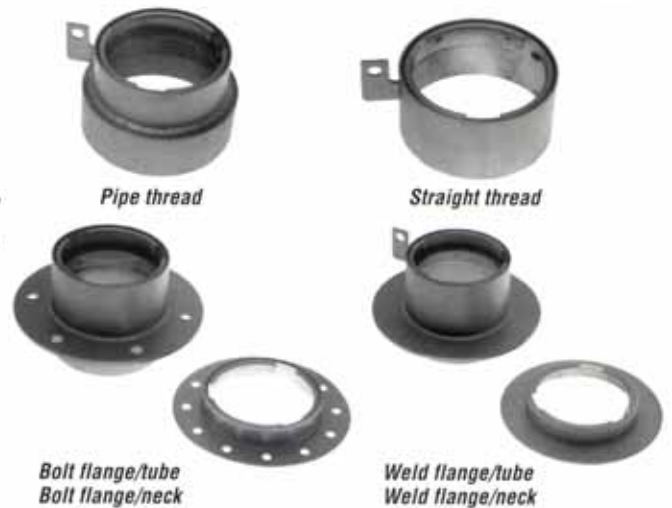

Pipe Thread	Straight Tube	Bolt Flange	Weld Flange
Steel only	Steel, Stainless Steel, or Aluminum	Tube Mount (Steel, Stainless Steel, or Aluminum) Neck Mount (Steel, Stainless Steel, or Aluminum)	Tube Mount (Steel or Stainless Steel) Neck Mount (Steel or Stainless Steel)

Call us first!

Wisco Products specializes in providing a full line of fluid filler components for all your engine and fluid containment systems. Chances are we have what you need in one of our standard products series. If not, we'll make it for you. Call Wisco first for high performance product and service on all your filler product needs.



Service and performance you can count on.